

Zen 5.536 Silver Air 66" x 36" x 23"

SKU: ZEN5536-SAIR



SILVER AIR

TECHNICAL SPECIFICATIONS	
Drain	End drain
Pump Location(s): Select 1	Std. = Standard / Alt LF/RF Optional
Bath Weight (empty)	180 lbs
Gallons to Operate	55-74
ELECTRICAL SPECIFICATIONS	
Motor/Pump	(1) 115v 20AMP GFCI Circuits

BATHERS: 1	
INSTALLATION	
•	DECK (D)
•	UNDER MOUNT (U)
•	ALCOVE (A)
	FREESTANDING (F)
	CLAWFOOT (L)
	PEDESTAL (P)

Jet & Control placement may vary



STANDARD FEATURES & ACCESSORIES for SILVER AIR

JETS

12 Classic Air Jets Sidewall ○

PUMPS

1.0 Air Power 3-Speed Warm Air Pump
Quiet Pad Anti-Vibration Mounted Pump

CONTROLS

Air Switch On/Off Control(s)
Automatic Purge & Dry Cycle Control

PURITY

HydroCleanse

STANDARD ACCESSORIES

EZ Level Adjustable Legs
FDA Recipe Non-Toxic Food & Beverage Grade Plumbing (primarily)
30 Point Quality Assurance Factory Test

REQUIREMENTS

Pump Locations: Select 1
Electrical: one 115v 20AMP GFCI Circuit
Tub should not be supported by the lip in any way.
Level tub & screw or glue EZ Level adjustable legs to sub floor.
CUT OUT DIMENSIONS:
OVALS: A template will be provided
RECTANGLES: Subtract 1" to 1.5" from length & width for hole cut out size

EZ CLEAN CAST ACRYLIC LIMITED LIFETIME WARRANTY **TEXTURED FLOOR**

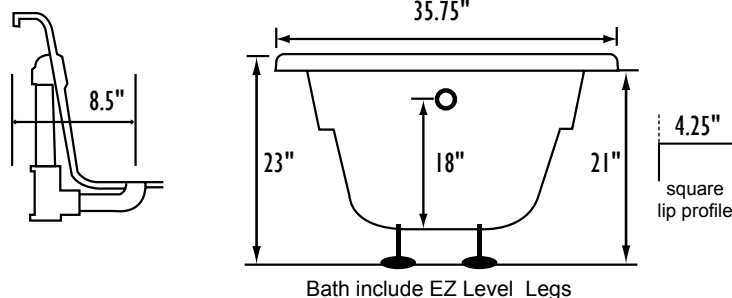

INSTALLATION WILL NOT REQUIRE MORTAR BEDDING

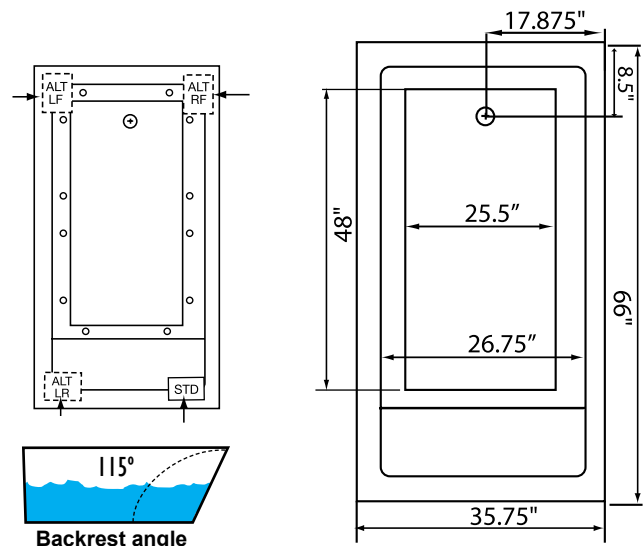

Some standard & most alternate pump locations may stickout past perimeter of the bath 1"-3". NOTE: Graphics may not be to scale. Specifications and features are subject to change without notice and are ± .25". All final measurements should be taken from tub on site. Access 18"x 18" or larger is required for each pump. Consult your contractor for installation requirements.