

Eclipse 536 Platinum Air 60" x 36" x 23"

SKU: ECLIPSE-536-PAIR



PLATINUM AIR

TECHNICAL SPECIFICATIONS	
Drain	End drain
Pump Location(s): Select 2	Std. = Standard / Alt LF/RF Optional
Bath Weight (empty)	135 lbs
Gallons to Operate	40-57
ELECTRICAL SPECIFICATIONS	
Motor/Pump	(1) 115v 20AMP GFCI Circuits
Whisper Flo Heat Pump System	(2) 115v 20AMP GFCI Circuit

BATHERS: 1	
INSTALLATION	
•	DECK (D)
	UNDER MOUNT (U)
	ALCOVE (A)
	FREESTANDING (F)
	CLAWFOOT (L)
	PEDESTAL (P)

Jet & Control placement may vary



STANDARD FEATURES & ACCESSORIES for PLATINUM AIR

JETS

- 34 EZ Clean Air Jets
- HTT Leg Therapy Air Massage Jets **X**
- HTT Back Therapy Air Massage Jets **X**

PUMPS

- 1.25 Air Power Variable Speed, Pulse & Wave heated Air Pump
- Quiet Pad Anti-Vibration Mounted Pump
- WhisperFlo Heat Pump System with Control & Ecobond Foam Insulation (must select Pump Locations)

HEATERS

- Stainless Steel Electric Heater
- Warm Back Rest Tubing Zone

CONTROLS

- Air Switch On/Off Control(s) for Chromatherapy
- Variable Speed Air Massage Control
- Automatic Purge & Dry Cycle Control

PURITY

- HydroClean Water Purity System
- HydroCleanse

STANDARD ACCESSORIES

- Grab Bar(s) - 2 on End Drain baths - White, Biscuit, Bone, Brushed Nickel, Polished Chrome
- Chromatherapy Lighting
- Deluxe Cable Drain - White, Biscuit, Bone, Brushed Nickel, Oil Rubbed Bronze, Polished Chrome
- Deluxe Cushion Pillow
- EZ Level Base
- FDA Recipe Non-Toxic Food & Beverage Grade Plumbing (primarily)
- 30 Point Quality Assurance Factory Test

REQUIREMENTS

- Pump Locations: Select 2
- Electrical: Three 115v 20AMP GFCI Circuits
- Drain and Grab Bars: Select Color / Finish
- Tube should not be supported by the lip in any way.**
- Level tub & screw or glue EZ Level adjustable legs to sub floor.**
- CUT OUT DIMENSIONS:**
 - OVALS:** A template will be provided
 - RECTANGLES:** Subtract 1" to 1.5" from length & width for hole cut out size

EZ CLEAN CAST ACRYLIC LIMITED LIFETIME WARRANTY  **US ANSI**

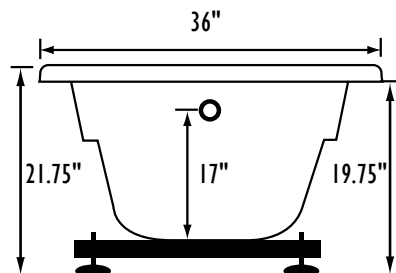
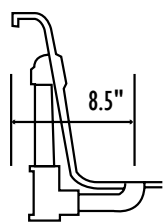
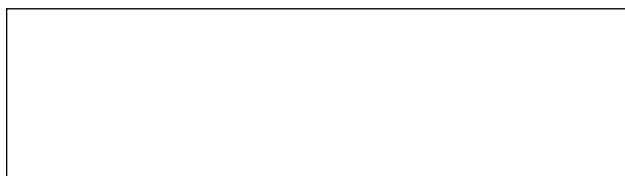

Bath include EZ Level Base

INSTALLATION WILL NOT REQUIRE MORTAR BEDDING

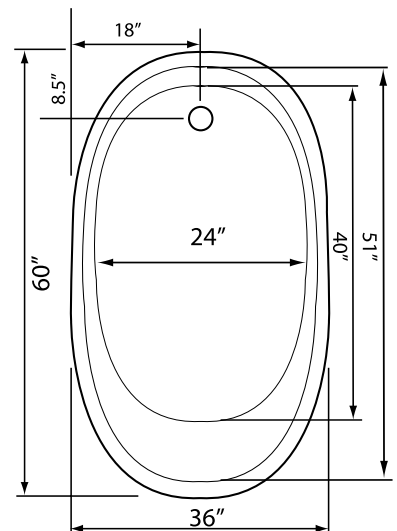
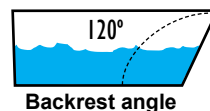
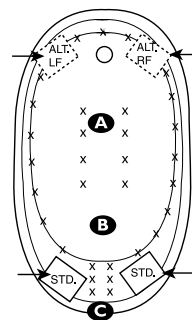
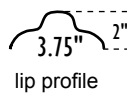

- A** **X** HTT® Leg Therapy Air Massage System includes 10 Air Jets on the floor. Optional on Combo Plat and Combo Gold Series
- B** **X** 6 Jet HTT® Back Massage System: N/A on Combo Series-Standard on Plat series
- C**  Warm Back Tubing Zone

Some standard & most alternate pump locations may stickout past perimeter of the bath 1"-3". NOTE: Graphics may not be to scale. Specifications and features are subject to change without notice and are ± .25". All final measurements should be taken from tub on site. Access 18"x 18" or larger is required for each pump. Consult your contractor for installation requirements.