

Zen Oval 7242 Silver Combination

72" x 42" x 24"

SKU: ZENOVAL7242-SCB



SILVER COMBINATION

TECHNICAL SPECIFICATIONS	
Drain	End drain
Pump Location(s): Select 2	Std. = Standard / Alt LF/RF Optional
Bath Weight (empty)	175 lbs
Gallons to Operate	77-95
ELECTRICAL SPECIFICATIONS	
Motor/Pump	(2) 115v 20AMP GFCI Circuits
Inline Stainless Steel Heater	(Opt.) 115v 20AMP GFCI Circuit

BATHERS: 1	
INSTALLATION	
•	DECK (D)
•	UNDER MOUNT (U)
	ALCOVE (A)
	FREESTANDING (F)
	CLAWFOOT (L)
	PEDESTAL (P)

Jet & Control placement may vary



STANDARD FEATURES & ACCESSORIES for SILVER COMBINATION

JETS

- 21 Air & Water Massage Jets
- Accumassage Back, Neck Jets
- Ultra Flow Jets
- Micro Flow Jets
- Classic Air Jets

PUMPS

- 2.25 Hydropower 1-speed Pump
- 1.0 Air Power 3-Speed Warm Air Pump
- Quiet Pad Anti-Vibration Mounted Pump

CONTROLS

- Air Switch On/Off Control(s)
- Automatic Purge & Dry Cycle Control

PURITY

- HydroClean Water Purity System
- HydroCleanse

STANDARD ACCESSORIES

- Mood Light
- Lift & Turn Drain - White, Biscuit, Bone, Brushed Nickel, Oil Rubbed Bronze, Polished Chrome
- Deluxe Cushion Pillow
- EZ Level Adjustable Legs
- FDA Recipe Non-Toxic Food & Beverage Grade Plumbing (primarily)
- 30 Point Quality Assurance Factory Test

REQUIREMENTS

- Pump Locations: Select 2
- Electrical: two 115v 20AMP GFCI Circuits
- Tube should not be supported by the lip in any way.**
- Level tub & screw or glue EZ Level adjustable legs to sub floor.**
- CUT OUT DIMENSIONS:**
 - OVALS:** A template will be provided
 - RECTANGLES:** Subtract 1" to 1.5" from length & width for hole cut out size

EZ CLEAN CAST ACRYLIC LIMITED LIFETIME WARRANTY

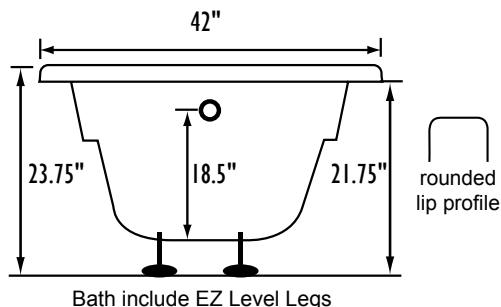
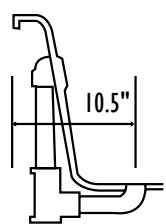

INSTALLATION WILL NOT REQUIRE MORTAR BEDDING

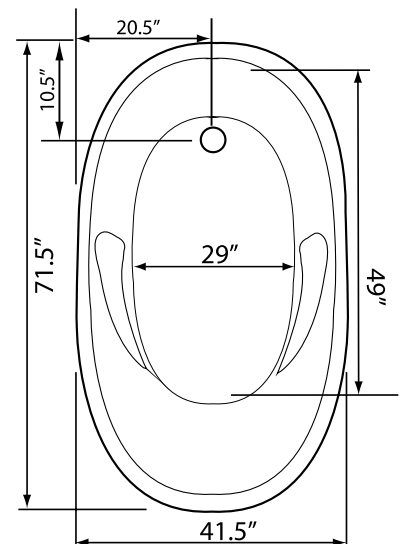
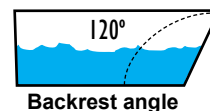
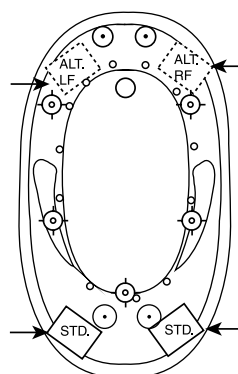

Some standard & most alternate pump locations may stickout past perimeter of the bath 1"-3". NOTE: Graphics may not be to scale. Specifications and features are subject to change without notice and are ± .25". All final measurements should be taken from tub on site. Access 18"x 18" or larger is required for each pump. Consult your contractor for installation requirements.