

Tranquility Platinum Water Jet 60" x 32" x 20"

SKU: TRANQ-PWJ



PLATINUM WATER JET

TECHNICAL SPECIFICATIONS	
Drain	End drain
Pump Location(s): Select 2	Std. = Standard / Alt LF/RF Optional
Bath Weight (empty)	140 lbs
Gallons to Operate	30-48
ELECTRICAL SPECIFICATIONS	
Motor/Pump	(2) 115v 20AMP GFCI Circuits
Inline Stainless Steel Heater	(1) 115v 20AMP GFCI Circuit

BATHERS: 1	
INSTALLATION	
	DECK (D)
	UNDER MOUNT (U)
•	ALCOVE (A)
	FREESTANDING (F)
	CLAWFOOT (L)
	PEDESTAL (P)

Jet & Control placement may vary



STANDARD FEATURES & ACCESSORIES for PLATINUM WATER JET

JETS

- 15 Water Jets
- Back Massage System(s) (7 Jets)
- Neck Massage Pillow (2 Jets) (⊕ ⊕)
- Sole Soother Jet(s) (⊗)
- Accumassage Back, Neck ⊕
- Ultra Flow Jets (⊖)

PUMPS

- Two 2.25 Hydropower 3-speed Pump (End Drain Tubs)
- Quiet Pad Anti-Vibration Mounted Pump

HEATERS

- Stainless Steel Electric Heater

CONTROLS

- Air Switch On/Off Control(s) For Chromatherapy Lighting
- Air Switch On/Off with digital Temperature Readout Control
- 3 Speed Massage: High, Medium or Low

PURITY

- HydroClean Water Purity System
- HydroCleanse

STANDARD ACCESSORIES

- Grab Bar(s) - 2 on End Drain baths - White, Biscuit, Bone, Brushed Nickel, Polished Chrome
- Chromatherapy Lighting
- Deluxe Cable Drain - White, Biscuit, Bone, Brushed Nickel, Oil Rubbed Bronze, Polished Chrome
- Deluxe Cushion Pillow on two person baths
- Neck Massage Pillow
- EZ Level Base
- FDA Recipe Non-Toxic Food & Beverage Grade Plumbing (primarily)
- 30 Point Quality Assurance Factory Test

REQUIREMENTS

- Pump Locations: Select 2
- Electrical: three 115v 20AMP GFCI Circuits
- Drain and Grab Bars: Select Color / Finish
- Tub should not be supported by the lip in any way.**
- Level tub & screw or glue EZ Level adjustable legs to sub floor.**
- CUT OUT DIMENSIONS:**
 - OVALS:** A template will be provided
 - RECTANGLES:** Subtract 1" to 1.5" from length & width for hole cut out size

EZ CLEAN CAST ACRYLIC LIMITED LIFETIME WARRANTY **US ANSI**

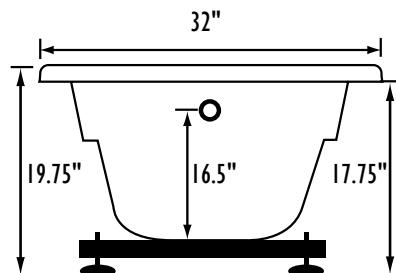
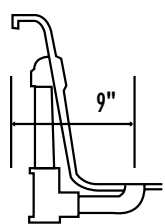
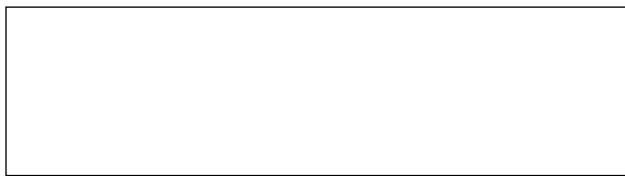

Bath include EZ Level Base

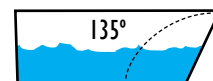
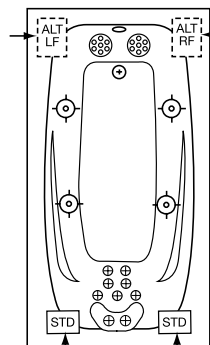
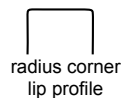

Backrest angle

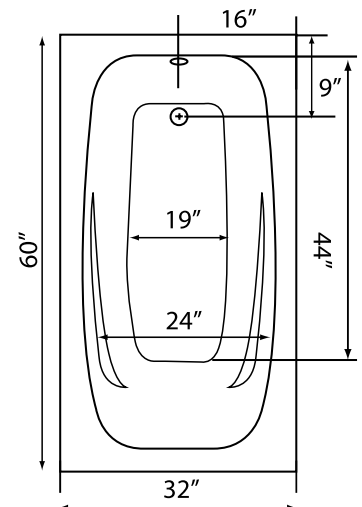

INSTALLATION WILL NOT REQUIRE MORTAR BEDDING

Some standard & most alternate pump locations may stickout past perimeter of the bath 1"-3". NOTE: Graphics may not be to scale. Specifications and features are subject to change without notice and are ± .25". All final measurements should be taken from tub on site. Access 18"x 18" or larger is required for each pump. Consult your contractor for installation requirements.