

# Tahoe 7444 Soaker 74" x 44" x 24"

SKU: TAHOE7444-SOAKER



TECHNICAL SPECIFICATIONS	
Drain	Side drain
Pump Location(s): N/A	Std. = Standard / Alt LF/RF Optional
Bath Weight (empty)	165 lbs
Gallons to Operate	57-75
ELECTRICAL SPECIFICATIONS	
Motor/Pump	N/A
Inline Stainless Steel Heater	N/A

BATHERS: 2	
INSTALLATION	
•	DECK (D)
	UNDER MOUNT (U)
	ALCOVE (A)
	FREESTANDING (F)
	CLAWFOOT (L)
	PEDESTAL (P)

## SOAKER



### STANDARD FEATURES & ACCESSORIES for SOAKER

#### STANDARD ACCESSORIES

EZ level Adjustable Legs

#### REQUIREMENTS

Tub should not be supported by the lip in any way.

Level tub & screw or glue EZ Level adjustable legs to sub floor.

#### CUT OUT DIMENSIONS:

**OVALS:** A template will be provided

**RECTANGLES:** Subtract 1" to 1.5" from length & width for hole cut out size

#### EZ CLEAN CAST ACRYLIC

LIMITED LIFETIME WARRANTY US ANSI

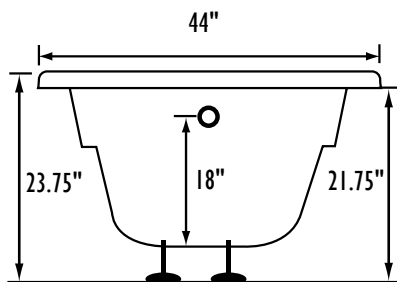
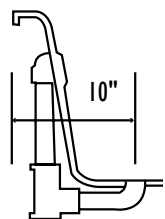
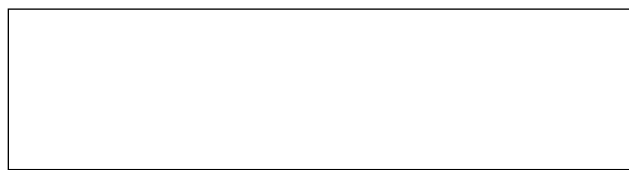

Bath includes EZ Level Legs

**INSTALLATION WILL NOT REQUIRE MORTAR BEDDING**

rounded lip profile

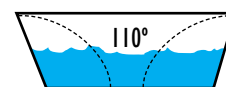
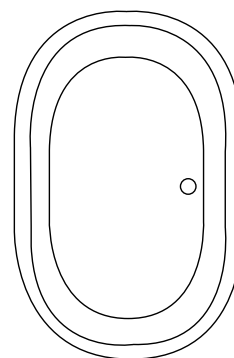

Backrest angle

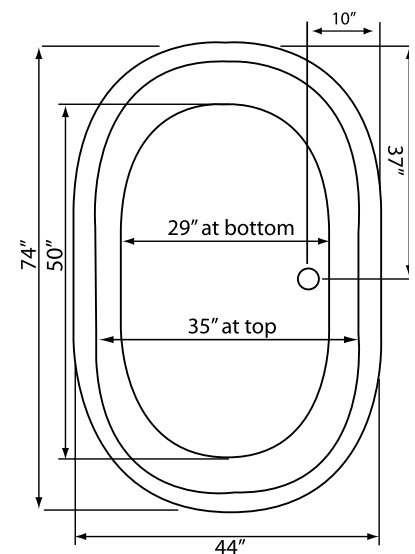

Some standard & most alternate pump locations may stickout past perimeter of the bath 1"-3". NOTE: Graphics may not be to scale. Specifications and features are subject to change without notice and are ± .25". All final measurements should be taken from tub on site. Access 18"x 18" or larger is required for each pump. Consult your contractor for installation requirements.