

Serenity 8 Gold Air 94" x 40" x 22"

SKU: SERENITY-8-GAIR



TECHNICAL SPECIFICATIONS	
Drain	End drain
Pump Location(s): Select 1	Std. = Standard / Alt LF/RF Optional
Bath Weight (empty)	215 lbs
Gallons to Operate	85-110
ELECTRICAL SPECIFICATIONS	
Motor/Pump	(1) 115v 20AMP GFCI Circuits

BATHERS: 1	
INSTALLATION	
•	DECK (D)
	UNDER MOUNT (U)
	ALCOVE (A)
	FREESTANDING (F)
	CLAWFOOT (L)
	PEDESTAL (P)

GOLD AIR

Jet & Control placement may vary



STANDARD FEATURES & ACCESSORIES for GOLD AIR

JETS

18 EZ Clean™ Air Jets on Sidewall **X**

PUMPS

1.25 Air Power Variable Speed, Pulse & Wave heated Air Pump
Quiet Pad Anti-Vibration Mounted Pump

HEATERS

Warm Back Rest Tubing Zone

CONTROLS

Air Switch On/Off Control(s) for mood lighting
Variable Speed Air Massage Control
Automatic Purge & Dry Cycle Control

PURITY

HydroCleanse

STANDARD ACCESSORIES

Mood Light
Lift & Turn Drain - White, Biscuit, Bone, Brushed Nickel, Oil Rubbed Bronze, Polished Chrome
Deluxe Cushion Pillow
EZ Level Adjustable Legs
FDA Recipe Non-Toxic Food & Beverage Grade Plumbing (primarily)
30 Point Quality Assurance Factory Test

COLOR

Only Available in White

REQUIREMENTS

Pump Locations: Select 1
Electrical: one 115v 20AMP GFCI Circuits
Drain: Select Color / Finish

Tub should not be supported by the lip in any way.

Level tub & screw or glue EZ Level adjustable legs to sub floor.

CUT OUT DIMENSIONS:

OVALS: A template will be provided

RECTANGLES: Subtract 1" to 1.5" from length & width for hole cut out size

EZ CLEAN CAST ACRYLIC LIMITED LIFETIME WARRANTY  **US ANSI**

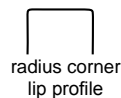
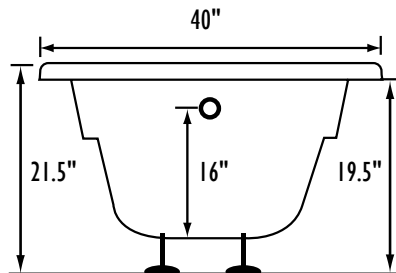
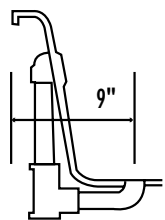

Bath include EZ Level Legs

INSTALLATION WILL NOT REQUIRE MORTAR BEDDING

- A** X HTT® Leg Therapy Air Massage System includes 10 Air Jets on the floor. Optional on Combo Plat and Combo Gold Series
- B** X 6 Jet HTT® Back Massage System: N/A on Combo Series-Standard on Plat series
- C**  Warm Back Tubing Zone

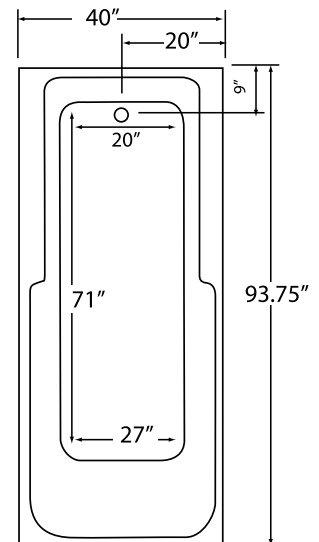
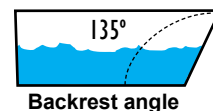
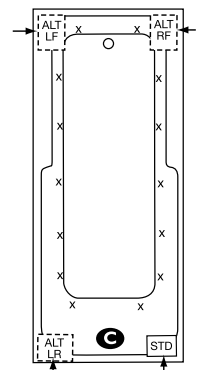

NOTE: Graphics may not be to scale. Specifications and features are subject to change without notice and are ± .25". All final measurements should be taken from **tub on site**. Access 18"x 18" or larger is required for each pump. Some pump locations and plumbing may extend beyond the perimeter of the bath.