

Serenity 7 Silver Water Jet 87"x36" x 21"

PRODUCT NUMBER: SERENITY7-SWJ



SILVER WATER JET

TECHNICAL SPECIFICATIONS	
Drain	End drain
Pump Location(s): Select 1	Std. = Standard / Alt LF/RF Optional
Bath Weight (empty)	180 lbs
Gallons to Operate	58-76
ELECTRICAL SPECIFICATIONS	
Motor/Pump	(1) 115v 20AMP GFCI Circuits
Inline Stainless Steel Heater	(Opt) 115v 20AMP GFCI Circuit



BATHERS: 1	
INSTALLATION	
•	DECK (D)
	UNDER MOUNT (U)
•	ALCOVE (A)
	FREESTANDING (F)
	CLAWFOOT (L)
	PEDESTAL (P)

Jet & Control placement may vary



STANDARD FEATURES & ACCESSORIES for SILVER WATER JET

JETS

- 9 Water Jets
- Tri-Zone Back Systems 3 Jets
- Ultra Flow Jets 
- Micro Flow Jets 

PUMPS

- 2.25 Hydropower 1-speed Pump
- Quiet Pad Anti-Vibration Mounted Pump

CONTROLS

- Air Switch On/Off Control(s)

PURITY

- HydroClean Water Purity System
- HydroCleanse

STANDARD ACCESSORIES

- FDA Recipe Non-Toxic Food & Beverage Grade Plumbing (primarily)
- 30 Point Quality Assurance Factory Test
- EZ Level Adjustable Legs

COLOR

Only Available in White

REQUIREMENTS

- Pump Locations: Select 1
- Electrical: one 115v 20AMP GFCI Circuits
- Tub should not be supported by the lip in any way.**
- Level tub & screw or glue EZ Level adjustable legs to sub floor.**
- CUT OUT DIMENSIONS:**
 - OVALS:** A template will be provided
 - RECTANGLES:** Subtract 1" to 1.5" from length & width for hole cut out size

EZ CLEAN CAST ACRYLIC

LIMITED LIFETIME WARRANTY 

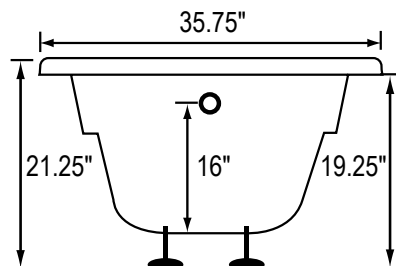
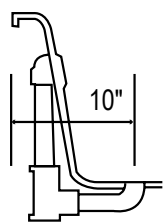

Bath include EZ Level Legs

INSTALLATION WILL NOT REQUIRE MORTAR BEDDING

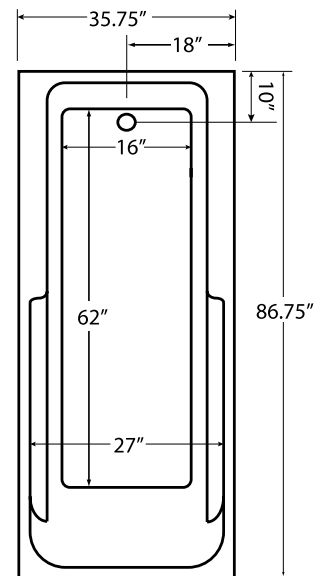
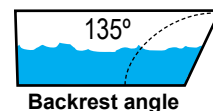
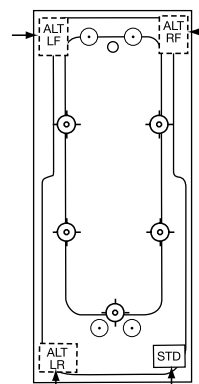

Some standard & most alternate pump locations may stick out past perimeter of the bath 1"-3". NOTE: Graphics may not be to scale. Specifications and features are subject to change without notice and are $\pm .25"$. All final measurements should be taken from tub on site. Access 18"x 18" or larger is required for each pump. Consult your contractor for installation requirements.