

Fantasy Silver Air Jet 72" x 42" x 27"

SKU: FANTASY-SAIR



Silver Air Jet

TECHNICAL SPECIFICATIONS	
Drain	Side drain
Pump Location(s): Select 1	Std. = Standard / Alt LF/RF Optional
Bath Weight (empty)	195 lbs
Gallons to Operate	74-120
ELECTRICAL SPECIFICATIONS	
Motor/Pump	(1) 115v 20AMP GFCI Circuits
Whisper Flo Heat Pump System	(2) 115v 20AMP GFCI Circuit (opt.)

BATHERS: 2	
INSTALLATION	
•	DECK (D)
	UNDER MOUNT (U)
	ALCOVE (A)
	FREESTANDING (F)
	CLAWFOOT (L)
	PEDESTAL (P)

Jet & Control placement may vary



STANDARD FEATURES & ACCESSORIES for Silver Air Jet

JETS

12 Classic Air Jets Sidewall

PUMPS

1.0 Air Power 3-Speed Warm Air Pump
Quiet Pad Anti-Vibration Mounted Pump

CONTROLS

Air Switch On/Off Control(s)
Automatic Purge & Dry Cycle Control

PURITY

HydroCleanse

STANDARD ACCESSORIES

EZ Level Adjustable Legs
FDA Recipe Non-Toxic Food & Beverage Grade Plumbing (primarily)
30 Point Quality Assurance Factory Test

REQUIREMENTS

Pump Locations: Select 1

Electrical: one 115v 20AMP GFCI Circuit

Tub should not be supported by the lip in any way. Level tub & screw or glue EZ Level adjustable legs to sub floor.

CUT OUT DIMENSIONS:

OVALS: A template will be provided

RECTANGLES: Subtract 1" to 1.5" from length & width for hole cut out size

EZ CLEAN CAST ACRYLIC LIMITED LIFETIME WARRANTY **us ANSI**

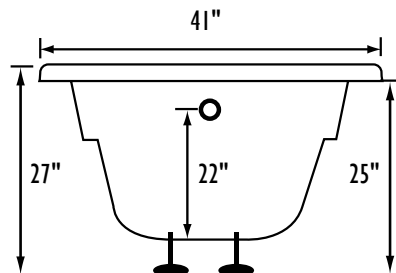
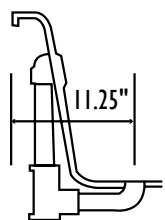
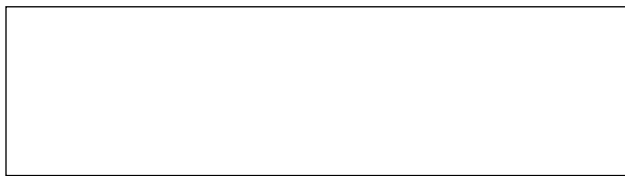

Bath includes EZ Level Legs

INSTALLATION WILL NOT REQUIRE MORTAR BEDDING

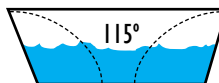
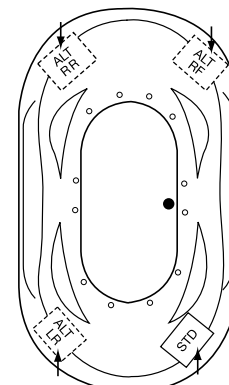
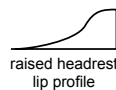

Backrest angle

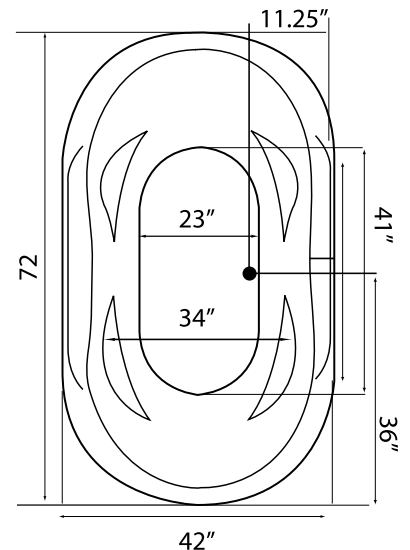

NOTE: Graphics may not be to scale. Specifications and features are subject to change without notice and are $\pm .25"$. All final measurements should be taken from **tub on site**. Access 18"x 18" or larger is required for each pump. Some pump locations and plumbing may extend beyond the perimeter of the bath.